Ambient Weather WS-09 8-Channel Wireless Refrigerator/Freezer Thermometer User Manual



Table of Contents

| | | |
|----|-----------------------------------------------------|----|
| 1 | Introduction | 2 |
| 2 | Getting Started | 2 |
| | Parts List | 2 |
| | 2.1 Probe Thermometer Sensor Set Up | 2 |
| | 2.2 Display Console Set Up | 4 |
| | 2.2.1 Display Console Layout | 5 |
| | 2.2.2 Sensor Operation Verification | 6 |
| 3 | Remote Sensor Installation | 6 |
| | 3.1 Refrigerator/Freezer Mounting | 7 |
| | 3.2 Wall Mounting | 8 |
| 4 | Console Operation | 9 |
| | 4.1 Channel Selection | 9 |
| | 4.2 Min and Max Alarm | 9 |
| | 4.2.1 Turning On and Off the Alarm | 9 |
| | 4.2.2 Alarm Defaults | 10 |
| | 4.2.3 Setting the Min and Max Alarm | 10 |
| | 4.2.4 Viewing the Min and Max Alarms | 10 |
| | 4.3 Reset Max/Min | 10 |
| | 4.4 Temperature Units of Measure | 10 |
| | 4.5 Sensor Search Mode | 10 |
| | 4.6 Best Practices for Wireless Communication | 11 |
| | 4.7 Adjustment or Calibration | 11 |
| 5 | Glossary of Terms | 12 |
| 6 | Specifications | 12 |
| | 6.1 Wireless Specifications | 12 |
| | 6.2 Measurement Specifications | 12 |
| | 6.3 Power Consumption | 12 |
| 7 | Troubleshooting Guide | 12 |
| 8 | Accessories | 14 |
| 9 | Liability Disclaimer | 14 |
| 10 | FCC Statement | 14 |
| 11 | Warranty Information | 15 |

1 Introduction

Thank you for your purchase of the Ambient Weather WS-09 8-Channel Wireless Refrigerator/Freezer Thermometer. The following user guide provides step by step instructions for installation, operation and troubleshooting. To download the latest manual and additional troubleshooting tips, please visit:

<http://ambientweather.wikispaces.com/ws09>

The probe thermometer allows you to measure the temperature inside a refrigerator or freezer, while mounting the display on the outside of the refrigerator/freezer.

Wireless signals cannot pass through a metal barrier. If your refrigerator/freezer is constructed of metal, the probe will have to be placed inside the refrigerator/freezer and the display/transmitter outside the refrigerator/freezer.

In addition to the refrigerator/freezer application, the probe thermometer can be placed in any medium where temperature is required, including ground temperature, air temperature and water temperature.

2 Getting Started

 **Note:** The power up sequence must be performed in the order shown in this section (insert batteries in the remote transmitter(s) first, Display Console second).

The WS-09 weather station consists of a display console (receiver), and two probe thermometers for the refrigerator/freezer.

Parts List

| QTY | Item |
|-----|--------------------------------------------------------------------------------------------------------------------------------------------|
| 1 | Display Console Frame Dimensions (LxHxW): 4.50 x 5.0 x 1.00 in LCD Dimensions (LxW): 3.75 x 3.50" LCD Segment Height: 1.25 inches |
| 2 | Probe thermometer transmitter with probe (FT007TP) for refrigerator/freezer Dimensions (LxHxW): 4.5" x 2.0" x 0.75" |
| 2 | Suction cup mounts |

2.1 Probe Thermometer Sensor Set Up

 **Note:** Do not use rechargeable batteries. We recommend fresh alkaline batteries for temperature ranges between -4 °F and 140 °F and fresh lithium batteries for temperature ranges between -40 °F and 140 °F.

1. Remove the battery door on the back of the sensor by removing the set screw, as shown in Figure 1 .

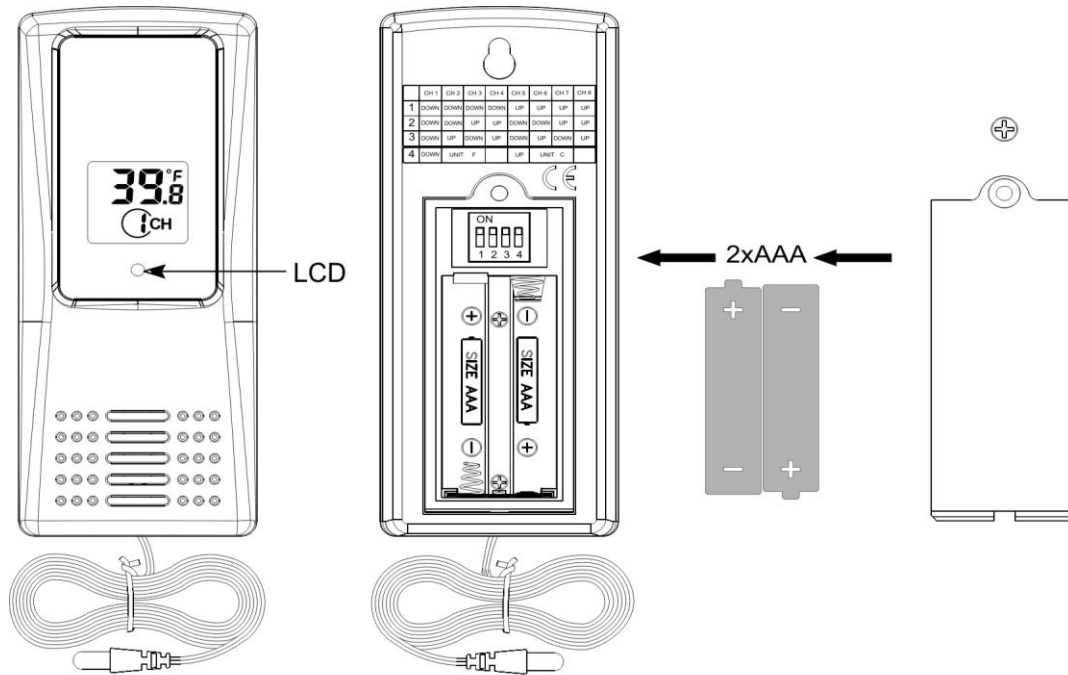

Figure 1

2. **BEFORE** inserting the batteries, locate the dip switches on the inside cover of the lid of the transmitter. Set the first transmitter to Channel 1 (refrigerator) and the second transmitter to Channel 2 (freezer). Figure 2 displays all four switches in the OFF position (factory default setting).



Figure 2

3. **Channel Number:** The WS-09 supports up to eight transmitters. To set each channel number (the default is Channel 1), change Dip Switches 1, 2 and 3, as referenced in Table 1.
4. **Temperature Units of Measure:** To change the transmitter display units of measure (°F vs. °C), change Dip Switch 4, as referenced in Table 1.

| DIP SWITCH | | | | FUNCTION |
|------------|------|------|------|--------------------------|
| 1 | 2 | 3 | 4 | |
| DOWN | DOWN | DOWN | --- | Channel 1 (refrigerator) |
| DOWN | DOWN | UP | --- | Channel 2 (freezer) |
| DOWN | UP | DOWN | --- | Channel 3 (optional) |
| DOWN | UP | UP | --- | Channel 4 (optional) |
| UP | DOWN | DOWN | --- | Channel 5 (optional) |
| UP | DOWN | UP | --- | Channel 6 (optional) |
| UP | UP | DOWN | --- | Channel 7 (optional) |
| UP | UP | UP | --- | Channel 8 (optional) |
| --- | --- | --- | DOWN | °F |
| --- | --- | --- | UP | °C |

Table 1

5. Insert two AAA batteries.
6. After inserting the batteries, the remote sensor LED indicator will light for 4 seconds, and then flash once per 60 seconds thereafter. Each time it flashes, the sensor is transmitting data.
7. Verify the correct channel number (CH) and temperature units of measure (°F vs. °C) are on the display, as shown in Figure 3.

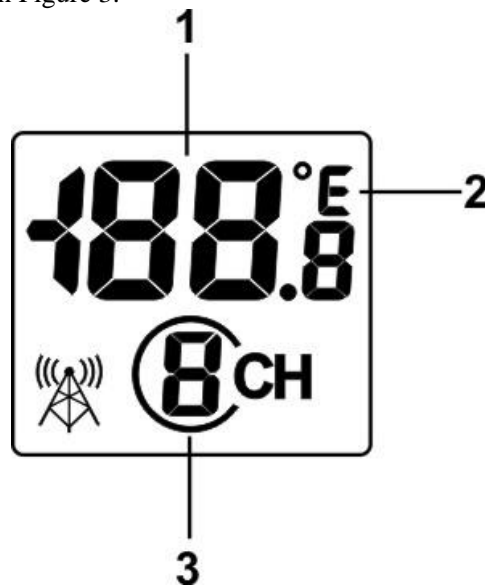

Figure 3

- (1) temperature
- (2) temperature units (°F vs. °C)
- (3) channel number

8. Close the battery door. Make sure the gasket (around the battery compartment) is properly seated in its trace prior to closing the door. Tighten the set screw.

2.2 Display Console Set Up

1. Move the remote probe thermometer(s) about 5 to 10' away from the display console (if the sensor is too close, it may not be received by the display console). If you have more than one probe thermometer, make sure they are all powered up and transmitting on different channels.
2. Remove the battery door on the back of the display, as shown in Figure 4. Insert four AAA

(alkaline or lithium, avoid rechargeable) batteries in the back of the display console.

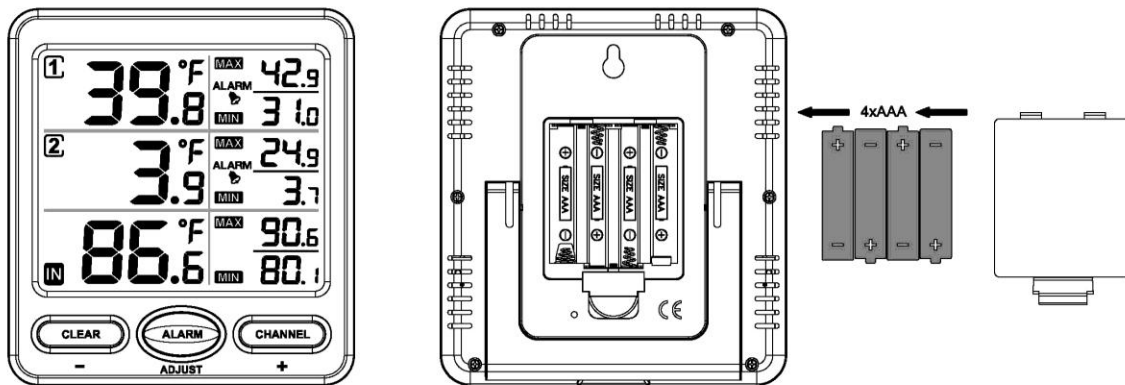



Figure 4

All of the LCD segments will light up for a few seconds to verify all segments are operating properly.

3. Replace the battery door, and fold out the desk stand and place the console in the upright position.

The console will instantly display indoor temperature as designated by the **IN** icon. The remote temperature probes will update on the display within a few minutes on the appropriate channel.

While in the search mode, the remote search icon  will be constantly displayed for each sensor.

If you have more than two remote sensors (additional channels 3-8 are supported), the display will automatically toggle between sensors until all sensors have reported in.

Do not touch any buttons until all of the remote sensors has reported in, or the radio search icon  is no longer visible, otherwise the remote sensor search mode will be terminated. When the remote sensor temperature has been received, the console will automatically switch to the normal mode, and all further settings can be performed.

If a remote does not update, please reference the troubleshooting guide in Section 7.

2.2.1 Display Console Layout

 **Note:** The following illustration shows the full segment LCD display for description purposes only, and will not appear like this during normal operation.

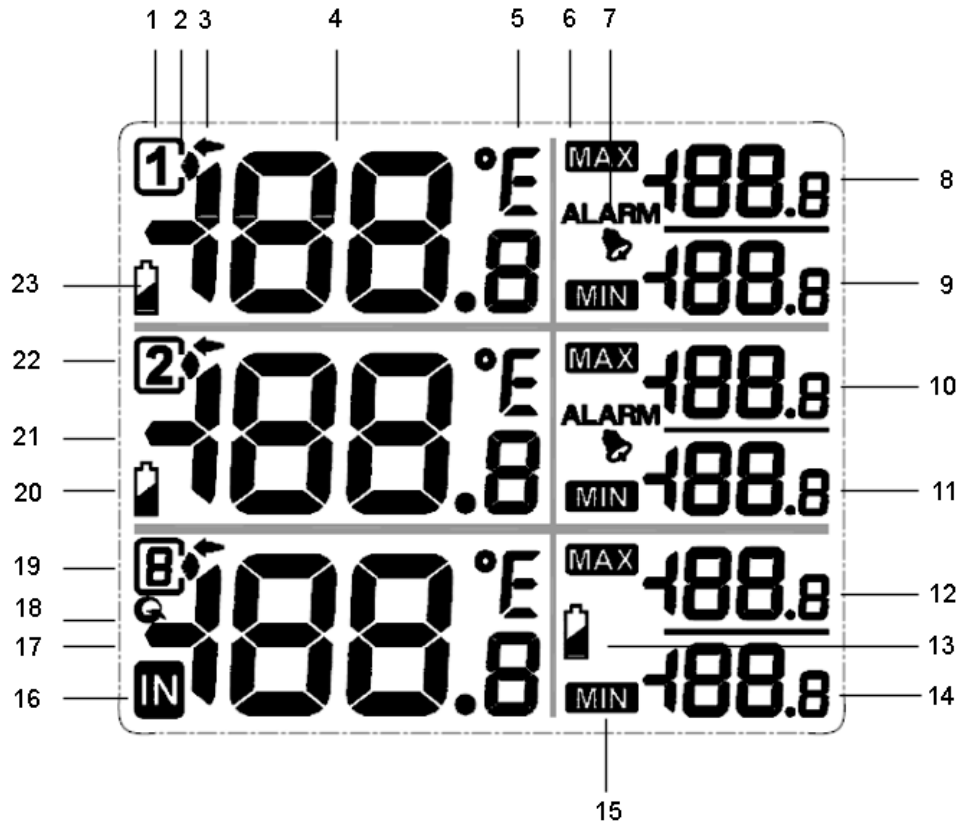

Figure 5

- | | |
|-----------------------------------------------------------------------------------------------------------------------------------------------------------------------------------------------------------------------------------------------------------------------------------------------------------------------------------------------------------------------------------------------------------------------------------------------------------------------------------------------------------------------------------------------------------------------------------------|-------------------------------------------------------------------------------------------------------------------------------------------------------------------------------------------------------------------------------------------------------------------------------------------------------------------------------------------------------------------------------------------------------------------------------------------------------------------------------------------------------|
| <ul style="list-style-type: none"> 1. Channel 1 Indicator 2. Reception Icon (solid when searching, flashes when updating) 3. Channel Selector 4. Channel 1 Temperature 5. Temperature units (°F or °C) 6. Max Temperature Indicator 7. Temperature Alarm 8. Maximum Temperature, Channel 1 9. Minimum Temperature, Channel 1 10. Maximum Temperature, Channel 2 11. Minimum Temperature, Channel 2 12. Maximum Temperature, Channels 3,4,5,6,7,8, IN indicator | <ul style="list-style-type: none"> 13. Low battery indicator 14. Minimum Temperature, 3,4,5,6,7,8, IN indicator 15. Min Temperature Indicator 16. Indoor Temperature Indicator 17. Temperature, Channels 3,4,5,6,7,8, IN 18. Scroll mode indicator 19. Channel indicator 20. Low battery indicator 21. Channel 2 Temperature 22. Channel 2 Indicator 23. Low battery indicator |
|-----------------------------------------------------------------------------------------------------------------------------------------------------------------------------------------------------------------------------------------------------------------------------------------------------------------------------------------------------------------------------------------------------------------------------------------------------------------------------------------------------------------------------------------------------------------------------------------|-------------------------------------------------------------------------------------------------------------------------------------------------------------------------------------------------------------------------------------------------------------------------------------------------------------------------------------------------------------------------------------------------------------------------------------------------------------------------------------------------------|

2.2.2 Sensor Operation Verification

Verify the temperature sensors match closely with the console and sensor array in the same location (about 5 to 10' apart). The sensors should be within 2°F (the accuracy is ± 1°F). Allow about 30 minutes for both sensors to stabilize. The temperature can be adjusted or calibrated later to match each other or a known source.

3 Remote Sensor Installation

The remote probe sensors have many applications, including measuring inside/outside air temperature, water temperature, soil or ground temperature and refrigerator / freezer temperatures.

3.1 Refrigerator/Freezer Mounting

Each sensor includes a detachable suction cup that may be used to secure the remote sensor to the interior or exterior surface of the refrigerator/freezer, as shown in Figure 6.

For better reception, we recommended installing the sensor to the outside of the refrigerator/freezer. If the refrigerator/freezer is a metal box, the wireless signal cannot escape, and the sensors must be placed on the outside.



Figure 6

To attach the suction cup to the remote sensor, reference Figure 7.

1. Locate the mounting hole on the back of the unit.
2. Press the suction cup into the mounting hole.
3. While applying pressure with your thumb, twist the suction cup until fully inserted.
4. Wet the back of the suction cup and apply to clean, smooth, flat surface.

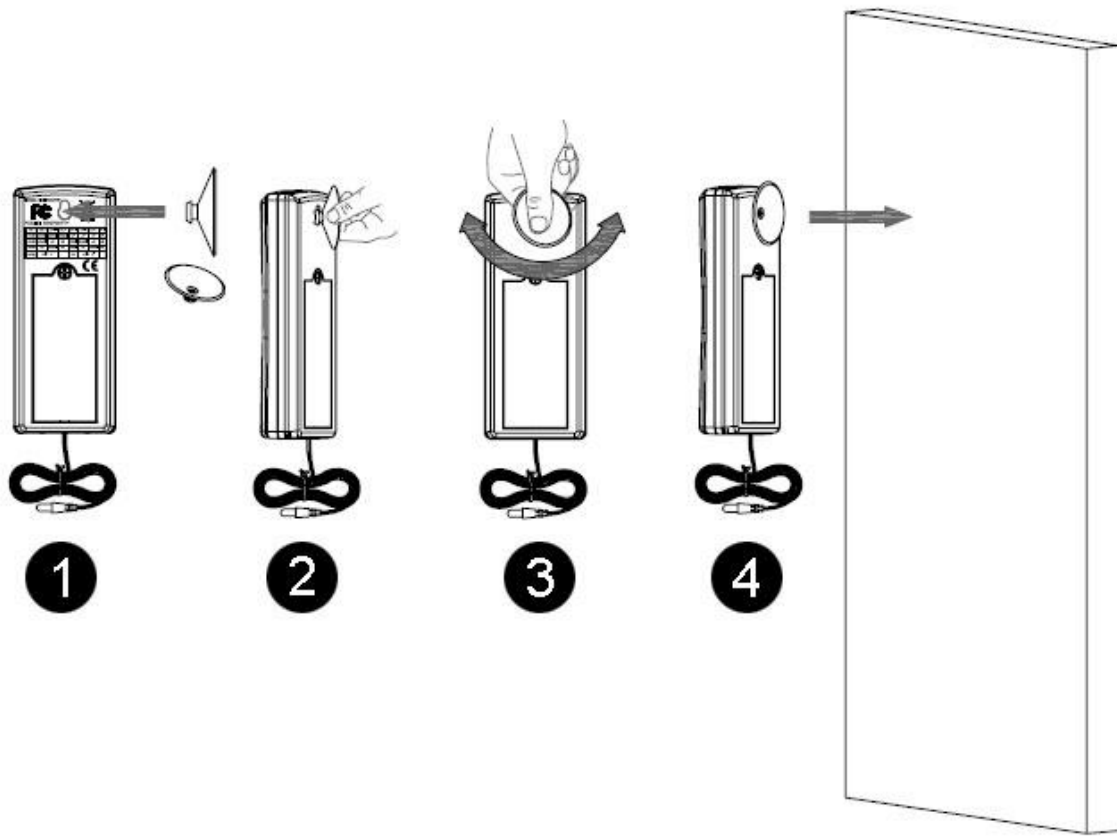



Figure 7

 **Note:** Both sensors have the capability of being placed inside or outside the refrigerator/freezer, but it is recommended you install it outside. This will extend the battery life, the sensor life, and improve wireless communication range.

 **Note:** Make sure that the refrigerator surface is smooth and clean, so that suction cups will not fall off. It is recommended to wet the surface of the suction cup first to improve the seal.

3.2 Wall Mounting

The remote sensor can be mounted to a wall or horizontal surface to measure any temperature medium, including air, water and soil.

Use a screw or nail (not included) to affix the remote sensor to the wall, as shown in Figure 8.

 **Note:** If measuring outside air temperature, we recommend mounting the sensor in the shade, on the north side of the house or structure to avoid radiant heat transfer.

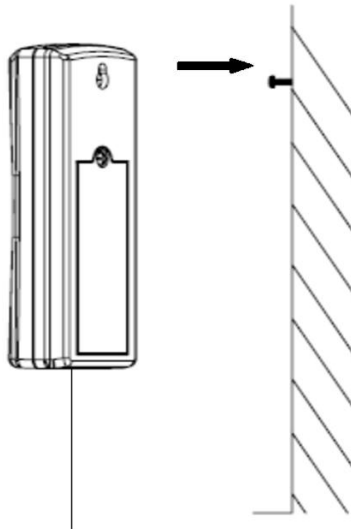





Figure 8

4 Console Operation

 **Note:** The console has three buttons for easy operation: **CLEAR/-** button, **ALARM/ADJUST** button, and **CHANNEL/+** button.

4.1 Channel Selection



Press the **CHANNEL/+** button to switch the display between the Channel 1 temperature, Channel 2 temperature, indoor temperature , remote sensors 3 through 8, and scroll mode . The channel indication arrow  will point at the selected channel. In scroll mode, the indoor temperature, and Channels 3-8 will alternately be displayed in five second intervals.

4.2 Min and Max Alarm

You can set a min and max temperature alarm on the Channel 1 and Channel 2 thermometers. If the alarm is exceeded for more than 10 minutes, an audible alert will occur and the alarm value will flash. To silence the alarm, press any button.

To set the alarm, or adjust the min and max alarm settings, press the **CHANNEL/+** button until the channel indication arrow  points at the selected channel.

4.2.1 Turning On and Off the Alarm

With the indicator arrow  pointing at the appropriate channel, press the **ALARM** button to turn on and off the alarm. The alarm icon will appear  when set, and disappear when disabled.

The alarm will sound if the sensor falls below or rises above the MIN/MAX limits for more than 10 minutes and the alarm icon  is present. This prevents false alarms from sounding when the refrigerator/freezer door is opened.

4.2.2 Alarm Defaults

| Channel | Application | Default Condition | MIN (low alarm) °F | MAX (high alarm) °F |
|---------|--------------|-------------------|--------------------|---------------------|
| 1 | Refrigerator | OFF | 33 | 40 |
| 2 | Freezer | OFF | -22 | 0 |

4.2.3 Setting the Min and Max Alarm

With the indicator arrow  pointing at the appropriate channel, press and hold the **ALARM** button for 3 seconds and the **MAX** alarm will flash. Press the **CHANNEL/+** button to increase the MAX alarm and the **CLEAR/-** button to decrease the MAX alarm. Press and hold the + or - button to change rapidly.

Press the **ALARM** button again and the MIN alarm will flash. Press the **CHANNEL/+** button to increase the MIN alarm and the **CLEAR/-** button to decrease the MIN alarm. Press and hold the + or - button to change rapidly.

When complete, press the **ALARM** button again, and the display will return to normal mode.

4.2.4 Viewing the Min and Max Alarms

With the indicator arrow  pointing at the indoor temperature **IN** channel, press the **ALARM** button to view the Channel 1 (refrigerator) and Channel 2 (freezer) alarm limits.

4.3 Reset Max/Min







With the indicator arrow  pointing at the appropriate channel, press and hold the **CLEAR/-** button for 3 seconds to restore the MAX and MIN values to the current value.

4.4 Temperature Units of Measure

With the indicator arrow  pointing at the indoor temperature **IN** channel, press and hold the **ALARM** button for 3 seconds to change between degrees Celsius and degrees Fahrenheit units of measure.

4.5 Sensor Search Mode

If any of the sensor communication is lost, dashes (---) will be displayed on the screen. To reacquire the signal:

1. If a specific channel is lost, press the **CHANNEL/+** button until the channel indication arrow  is pointing at the appropriate channel.
Press and hold the **CHANNEL/+** button for 3 seconds, and the remote search icon  will be constantly displayed for up to 10 minutes.
Once the signal is reacquired, the remote search icon  will turn off, and the current value will be displayed.
2. If new sensors are added, subtracted, or multiple sensor channels are lost, press the **CHANNEL/+** button until the channel indication arrow  is pointing at the indoor temperature **IN**. Press and hold the **CHANNEL/+** button for 3 seconds, and the remote search icon  will be constantly displayed for up to 10 minutes. Once the signal is reacquired, the remote search icon  will turn off, and the current value will be displayed.

4.6 Best Practices for Wireless Communication

Wireless communication is susceptible to interference, distance, walls and metal barriers. We recommend the following best practices for trouble free wireless communication.

1. **Electro-Magnetic Interference (EMI).** Keep the console several feet away from computer monitors and TVs.
2. **Radio Frequency Interference (RFI).** If you have other 433 MHz devices and communication is intermittent, try turning off these other devices for troubleshooting purposes. You may need to relocate the transmitters or receivers to avoid intermittent communication.
3. **Line of Sight Rating.** This device is rated at 300 feet line of sight (no interference, barriers or walls) but typically you will get 100 feet maximum under most real-world installations, which include passing through barriers or walls.
4. **Metal Barriers.** Radio frequency will not pass through metal barriers such as aluminum siding. If you have metal siding, align the remote and console through a window to get a clear line of sight.

4.7 Adjustment or Calibration

 **Note:** The calibrated value can only be adjusted on the console. The remote sensor(s) always displays the un-calibrated or measured value.

 **Note:** The purpose of calibration is to fine tune or correct for any sensor error associated with the devices margin of error. The measurement can be adjusted from the console to calibrate to a known source.

Calibration is only useful if you have a known calibrated source you can compare it against, and is optional. This section discusses practices, procedures and sources for sensor calibration to reduce manufacturing and degradation errors. Do not compare your readings obtained from sources such as the internet, radio, television or newspapers. They are in a different location and typically update once per hour.

The purpose of your weather station is to measure conditions of your surroundings, which vary significantly from location to location.

Prior to entering the calibration mode, press the **CHANNEL/+** button until the channel indication arrow  is pointing at the appropriate channel.

To enter the temperature calibration mode, press and hold the **ALARM/ADJUST** and **CHANNEL/+** buttons at the same time for 5 seconds and the temperature value will begin flashing. Press the **CHANNEL/+** button to increase the temperature and the **CLEAR/-** button to decrease the temperature reading in 0.1° increments. To rapidly increase (or decrease) the temperature reading, press and hold the **CHANNEL/+** or **CLEAR/-** button.

To return the temperature to the actual or uncalibrated measurement, press the **ALARM/ADJUST** button.

Once the displayed temperature equals the calibrated source, press and hold the **ALARM/ADJUST** button for three seconds, or wait 15 seconds for timeout, and the temperature value will stop flashing.

 **Discussion:** Temperature errors can occur when a sensor is placed too close to a heat source (such as a building structure, the ground or trees).

To calibrate temperature, we recommend a mercury or red spirit (fluid) thermometer. Bi-metal (dial) and other digital thermometers are not a good source and have their own margin of error. Using a local weather station in your area is also a poor source due to changes in location, timing (airport weather stations are only updated once per hour) and possible calibration errors (many official weather stations are not properly installed and calibrated).

Place the sensor in a controlled environment next to the fluid thermometer, and allow the sensor to stabilize for 48 hours. Compare this temperature to the fluid thermometer and adjust the console to match the fluid thermometer.

5 Glossary of Terms

| Term | Definition |
|----------|---------------------------------------------------------------------------------------------------------------|
| Accuracy | Accuracy is defined as the ability of a measurement to match the actual value of the quantity being measured. |
| Range | Range is defined as the amount or extent a value can be measured. |

6 Specifications

6.1 Wireless Specifications

- Line of sight wireless transmission (in open air): 300 feet, 100 feet under most conditions.
- Frequency: 433 MHz
- Update Rate: 60 seconds

6.2 Measurement Specifications

The following table provides specifications for the measured parameters.

| Measurement | Range | Accuracy | Resolution |
|-------------------------|---------------|----------|------------|
| Indoor Temperature | 32 to 140 °F | ± 1 °F | 0.1 °F |
| Channel 1-8 Temperature | -40 to 140 °F | ± 1 °F | 0.1 °F |



6.3 Power Consumption

- Base station (display console) : 4 x AAA 1.5V Alkaline or Lithium batteries (not included)
- Remote sensor : 2 x AAA 1.5V Alkaline or Lithium batteries (not included)
- Battery life: Minimum 12 months for base station with one sensor and excellent reception. Intermittent reception and multiple sensors may reduce the battery life. Minimum 12 months for thermometer probe sensor (use lithium batteries for temperatures less than -4 °F)

7 Troubleshooting Guide

If your question is not answered here, you can contact us as follows:

1. Email Support: support@ambientweather.com
2. Live Chat Support: www.ambientweather.com/chat.html (M-F 8am to 4pm Arizona Time)
3. Technical Support: 480-283-1644 (M-F 8am to 4pm Arizona Time)

| Problem | Solution |
|-------------------------------------------------------------------------------------------------------------------------------|----------------------------------------------------------------------------------------------------------------------------------------------------------------------------------------------------------------------------------------------------------------------------------------------------------------------------------------------------------------------------------------------------------------------------------------------------------------------------------------------------------------------------------------------------------------------------------------------------------------------------------------------------------------------------------------------------------------------------------------------------------------------------------------------------------------------------------------------------------------------------------------------------------------------------------------------------------------------------------------------------------------------------------------------------------------------------------------------------------------------------------------------------------------------------------------------------------------------------------------------------------------------------------------------------------------------------------------------------------------------------------------------------------------------------------------------------------|
| <p>Wireless remote (probe thermometer) not reporting in to console.</p> <p>There are dashes (---) on the display console.</p> | <p>If any of the sensor communication is lost, dashes (---) will be displayed on the screen. To reacquire the signal, press and hold the CHANNEL/+ button for 3 seconds, and the remote search icon  will be constantly displayed. Once the signal is reacquired, the remote search icon  will turn off, and the current values will be displayed.</p> <p>The maximum line of sight communication range is 300' and 100' under most conditions. Move the sensor assembly closer to the display console.</p> <p>If the sensor assembly is too close (less than 5'), move the sensor assembly away from the display console.</p> <p>Make sure the remote sensor LCD display is working and the transmitter light is flashing once per 60 seconds.</p> <p>Install a fresh set of batteries in the remote probe thermometer. For cold weather environments, install lithium batteries.</p> <p>Make sure the remote sensors are not transmitting through solid metal (acts as an RF shield), or earth barrier (down a hill).</p> <p>Move the display console around electrical noise generating devices, such as computers, TVs and other wireless transmitters or receivers.</p> <p>Move the remote sensor to a higher location. Move the remote sensor to a closer location.</p> |
| <p>Temperature sensor reads too high in the day time.</p> | <p>Make sure the probe thermometer is mounted in a shaded area on the north facing wall. Consider the following radiation shield if this is not possible: http://www.ambientweather.com/amwespatean.html</p> |
| <p>Indoor and Outdoor Temperature do not agree</p> | <p>Allow up to one hour for the sensors to stabilize due to signal filtering. The indoor and outdoor temperature sensors should agree within 2 °F (the sensor accuracy is ± 1 °F).</p> <p>Use the calibration feature to match the indoor and outdoor temperature to a known source.</p> |
| <p>Display console contrast is weak</p> | <p>Replace console batteries with a fresh set of batteries.</p> |

8 Accessories

The following software and hardware accessories are available for this weather station at www.AmbientWeather.com.

| Accessory | Description |
|-----------------------------------------------------------------------------------------------------|-----------------------------------------------------------------------------------------------------------------------|
| Ambient Weather F007TP Wireless Probe thermometer for WS-09 Weather Stations | Add additional remote probe thermometers. Supports up to eight remote sensors. |
| Ambient Weather F007T Wireless Thermometer for WS-09 Weather Stations | Add additional indoor/outdoor temperature sensors. Supports up to eight remote sensors. |
| Ambient Weather WS-09-C WS-09 Console Only | Add as many display consoles as you like to your existing system to display the remote sensor in different locations. |
| Energizer AAAS Lithium Battery (2-pack) - Batteries for Long Life and Cold Climates | AAA lithium batteries for cold weather climates. |

9 Liability Disclaimer

Please help in the preservation of the environment and return used batteries to an authorized depot. The electrical and electronic wastes contain hazardous substances. Disposal of electronic waste in wild country and/or in unauthorized grounds strongly damages the environment.

Reading the “User manual” is highly recommended. The manufacturer and supplier cannot accept any responsibility for any incorrect readings and any consequences that occur should an inaccurate reading take place.

This product is designed for use in the home only as indication of weather conditions. This product is not to be used for medical purposes or for public information.

The specifications of this product may change without prior notice.

This product is not a toy. Keep out of the reach of children.

No part of this manual may be reproduced without written authorization of the manufacturer.

Ambient, LLC WILL NOT ASSUME LIABILITY FOR INCIDENTAL, CONSEQUENTIAL, PUNITIVE, OR OTHER SIMILAR DAMAGES ASSOCIATED WITH THE OPERATION OR MALFUNCTION OF THIS PRODUCT.

10 FCC Statement

Statement according to FCC part 15.19:

This device complies with part 15 of the FCC rules. Operation is subject to the following two conditions:

1. This device may not cause harmful interference.
2. This device must accept any interference received, including interference that may cause undesired operation.

Statement according to FCC part 15.21:

Modifications not expressly approved by this company could void the user's authority to operate the equipment.

Statement according to FCC part 15.105:

NOTE: This equipment has been tested and found to comply with the limits for a Class B digital device, pursuant to Part 15 of the FCC Rules. These limits are designed to provide reasonable protection against harmful interference in a residential installation. This equipment generates, uses and can radiate radio frequency energy and, if not installed and used in accordance with the instructions, may cause harmful interference to radio communications.

However, there is no guarantee that interference will not occur in a particular installation. If this equipment does cause harmful interference to radio or television reception, which can be determined by turning the equipment off and on, the user is encouraged to try to correct the interference by one or more of the following measures:

- Reorient or relocate the receiving antenna.
- Increase the separation between the equipment and receiver.
- Connect the equipment into an outlet on a circuit different from that to which the receiver is connected.
- Consult the dealer or an experienced radio/TV technician for help.

11 Warranty Information

Ambient, LLC provides a 1-year limited warranty on this product against manufacturing defects in materials and workmanship.

This limited warranty begins on the original date of purchase, is valid only on products purchased and only to the original purchaser of this product. To receive warranty service, the purchaser must contact Ambient, LLC for problem determination and service procedures.

Warranty service can only be performed by a Ambient, LLC. The original dated bill of sale must be presented upon request as proof of purchase to Ambient, LLC.

Your Ambient, LLC warranty covers all defects in material and workmanship with the following specified exceptions: (1) damage caused by accident, unreasonable use or neglect (lack of reasonable and necessary maintenance); (2) damage resulting from failure to follow instructions contained in your owner's manual; (3) damage resulting from the performance of repairs or alterations by someone other than an authorized Ambient, LLC authorized service center; (4) units used for other than home use (5) applications and uses that this product was not intended (6) the products inability to receive a signal due to any source of interference or metal obstructions and (7) extreme acts of nature, such as lightning strikes or floods.

This warranty covers only actual defects within the product itself, and does not cover the cost of installation or removal from a fixed installation, normal set-up or adjustments, claims based on misrepresentation by the seller or performance variations resulting from installation-related circumstances.

